



AHB80X04R-MH-V2

Feature:

- Support H.265+ encoding, ultra-low bitrates, compatible with H.264 surroundings;
- Support VGA, HDMI full HD output simultaneously;
- Support ONVIF; access third party;
- Support multiple cloud technology, network penetration, alarm information pushed to your phone and other functions;
- Support web, VMS, center platform management software MYEYE, provide SDK development;
- Support various mobile monitoring (iPhone, Android);
- Remote Access, With DNS (ARSP),easy to monitor remotely
- Support UTC, control signal& video stream transmit through one single coaxial
- Support XVI/AHD/TVI/CVI/CVBS/IP six signals;



Specification:

	Model	AHB80X04R-MH-V2
System	Main processor	XM8520
Interface	Preview	1/4/8/9
Video	Codec	H.265+
	Monitor quality	VGA(1080P at most);HDMI(1080P at most)
	Preview ability	4*5M-N@20fps (6 in 1) /4*4M-N@25fps (6 in 1) /4*1080P (6 in 1) default:5M-N
	Encode ability	4*5M-N@12fps (6 in 1) /4*4M-N@12fps (6 in 1) /4*1080P@12fps (6 in 1) default:5M-N
	Decode ability	2*5M-N@12fps (6 in 1) /2*4M-N@12fps (6 in 1) /4*1080P@12fps (6 in 1) default:5M-N
	Multi-mode input	Analog: 4*5M-N; 4*1080P; 4*4M-N network: 8*5M
	Digital to analog conversion	Unsupport (except hybrid mode)
	Motion Detection	Each screen can be set to 192 (16 * 12) detection areas; multi-level sensitivity can be set (Limited local channel)
Audio	Audio compression	G.711A
	Intercom	support
Record & playback	Record mode	manual>alarm>motion detection>timing
	Local Playback	2ch(analog input mode)
	Search mode	Search by time, calendar, event, channel
Storage & backup	Video storage	HDD, network
	Backup mode	Network, USB hard disk, USB burner, SATA burner
External Interface	Video input	4ch BNC
	Video output	1ch VGA, 1ch HDMI
	Loop Vout	N/A
	Audio I/O	1/1
	Alarm I/O	0/0
	Network interface	RJ45 10M/100M self-adaption
	PTZ control	Support kinds of PTZ protocols
	USB	2* USB 2.0 ports
	HDD	1*SATA ports (Max 14TB/per)
	Wireless	3G, WIFI (extend via USB)
General	Power supply	12V/2A



Power Consumption	<15W (without HDD)
Working environment	Temperature:0℃—+55℃, Humidity:10%—90%, Atm:86kpa—106kpa
Dimension	134.5mm*60mm
Weight	90g

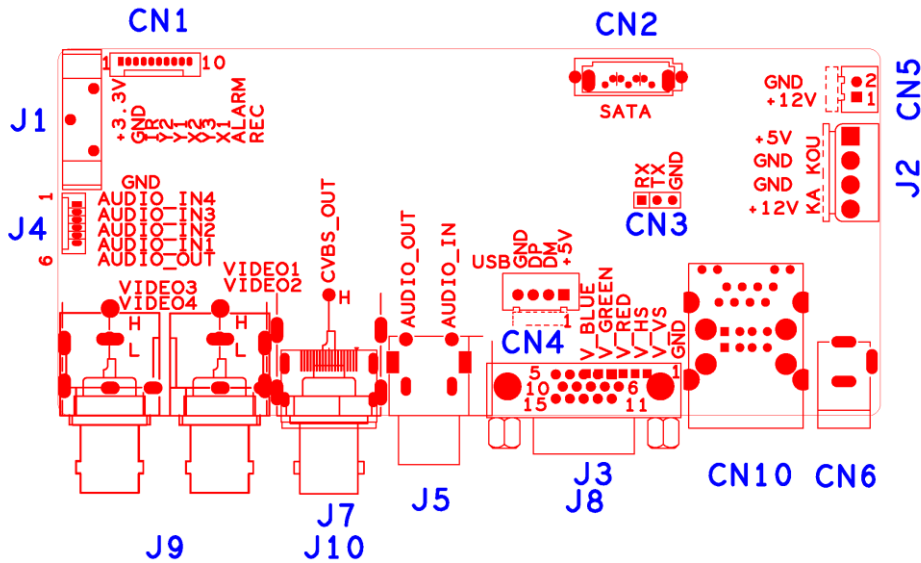

Socket	Function	Interface Description			
CN6	12V input				
CN10	2USB+RJ45				
J8	VGA				
J3	Extended VGA socket	1:GND	2:VGA_VS	3:VGA_HS	4:VGA_RED
		5:VGA_GREEN	6:VGA_BLUE		
J5	Audio RCA combination interface	Down :AUDIO_OUT_MAIN	up:AUDIO1		
J10	CVBS				
J7	HDMI				
CN7	4ch BNC Video input	Left down:VIDEO4	Left up:VIDEO3	Right down:VIDEO2	Right up:VIDEO1
J4	Audio expansion seat	1:GND	2:ADUIO_IN4	3:ADUIO_IN3	4:ADUIO_IN2
		5:ADUIO_IN1	6:ADUIO_OUT		
J1	RTC Battery seat				
CN1	10PIN without MCU front panel socket	1:+3.3V	2: GND	3:IR	4:COL1
		5:COL3	6:COL4	7: ROW7	8: COL2
		9: ALARM	10:REC		
CN2	SATA				
J2	SATA power socket	1: +5V	2:GND	3:GND	4:+12V
CN4	USB expansion seat	1:+5V	2: DM	3:DP	4:GND
CN5	Fan power socket	1: +12V	2:GND		